



Congratulations on your purchase of the *h1000 Pilot* from B&G. The *h1000 Pilot* is the latest in autopilots from B&G and represents B&G's commitment to providing our customers with the finest marine navigation systems. The *h1000 Pilot* is an easy to use, state-of-the-art computerised electronic autopilot system designed as a sophisticated navigation aid and provides many useful features.

Before you begin using your new *h1000 Pilot*, please take the time to read this manual to help you achieve the full potential from your new system.

features

features

The *h1000 Pilot* is a fully functional autopilot which can be used either as a stand-alone system or integrated into an instrument system.

- Steer to Compass heading, **COMP Mode**
- Steer to Wind angle, **Wind Mode**, when connected to the h1000 Wind Interface
- Steer to Waypoint, **Nav Mode**, either from the *h1000 CND* or NMEA via the Universal Interface
- Advanced Control Processor (ACP) with self-learning capabilities
- Red background illumination level in 3 steps from zero to full brightness



warnings & precautions:

WARNING:

DO NOT USE AN ALCOHOL BASED CLEANER ON THIS DISPLAY.

Note:

This equipment generates, uses, and can radiate radio frequency energy and, if not installed and used in accordance with the instructions, may cause harmful interference to radio communications. However, there is no guarantee that interference will not occur in a particular installation. If this equipment does cause harmful interference, the user is encouraged to try to correct the interference by relocating the equipment or connecting the equipment to a different circuit. Consult an authorised dealer or other qualified technician for additional help if these remedies do not correct the problem.

This device meets requirements for CFR47 Part 15 of the FCC limits for Class B equipment.

The *h1000 Pilot* meets the standards set out in European Standard EN 60945: 1997 IEC 945: 1996 for maritime navigation and radiocommunication equipment and systems.

The *h1000* contains no user-serviceable parts. An authorised service centre should only make repairs. Unauthorised repairs or modifications will void your warranty.

trademarks

All rights reserved. No part of this manual may be reproduced or transmitted in any form or by any means including photocopying and recording, for any purpose without the express written permission of B&G.









Information in this document is subject to change without notice. B&G reserves the right to change or improve its products and to make changes in the content without obligation to notify any person or organisation of such changes.

B&G and *h1000* are all trademarks of Brookes & Gatehouse Ltd. and may not be used without the express permission of B&G.

Overview	1	
Features	1	
Certification	2	
Trademarks	2	
Contents	3	
Controls	5	
Getting Started	5	
Engaging Pilot		6
Disengaging Pilot		6
Pilot mode selection	6	
Compass Mode		7
Navigate Mode		9
Wind Mode		10
Main menu	11	
Main Menu		11
Tack		11
Memories		11
Pilot Memories		11
Resume		11
Tack		12
TWA Mode		12
Speed Source		12
Memories Menu	13	
Compass		13
Reset trip log		13
Alarms		13
Lighting		14
Timer		15
Calibration	16	
Entering Secure Mode		16
Installation	17	
Precautions		17
Panel mounting		17
Electrical Connections	18	
External Connections		18
Accessories	19	
Hand-Held Controller		19
Joystick		20
Engaging the Pilot in Joystick Mode		20
Disengaging the Pilot in Joystick Mode		21

contents

Man Overboard (MOB) Mode	22	
Man Overboard Key		22
Power Boats		22
Sail Boats		22
MOB Manual Recovery: For All Boats, Pilot OFF		23
Manual Recovery: for all Boats, Pilot ON		23
MOB Automatic Recovery: Power Only, Pilot ON		24
Technical Specifications	25	
Warranty	26	

	<p>Light control</p> <p>The lighting level can be changed at any time by pressing the LIGHTS key. This causes the lighting level to cycle in the sequence high – medium – low – off and then back to high.</p>
	<p>The UP/DOWN keys are used to move through data pages, scroll through items in a list, and alter numerical values.</p>
	<p>Press the ENTER key to select the Main Menu from a data page, select items from a list entry, and store values to memory.</p>
	<p>ON engages the Pilot in the selected mode.</p>
	<p>OFF disengages the Pilot from all modes.</p>
	<p>The rotary knob is used to alter the Pilot course in 1° increments, scroll through items in a list, and alter numerical values.</p>
	<p>Alters the Pilot course by 10° to port. Multiple key presses are used for large course changes.</p>
	<p>Alters the Pilot course by 10° to starboard. Multiple key presses are used for large course changes.</p>
	<p>Successively cycles through Compass, Wind and Nav modes if available.</p>

getting started

Before switching the Pilot on for the first time, check that the installation has been wired according to the instructions contained in the *h1000 Pilot Installation Manual*.



After initial power-up the Pilot displays **Comp Mode** and shows the Pilot status as **OFF**.

Pressing the **MODE** key with the Pilot **OFF** scrolls through the available Pilot modes **Comp**, **Wind** and **Nav** providing the data is available on the system.

Pressing the **UP/DOWN** keys with the Pilot **OFF** the display scrolls through the six user pages returning to **OFF Comp Mode**.

engaging pilot

Pressing the **ON** key activates the Pilot in the selected mode.

Pressing the **UP/DOWN** keys with the Pilot **ON**, the display scrolls through the fixed Pilot pages for the selected mode.

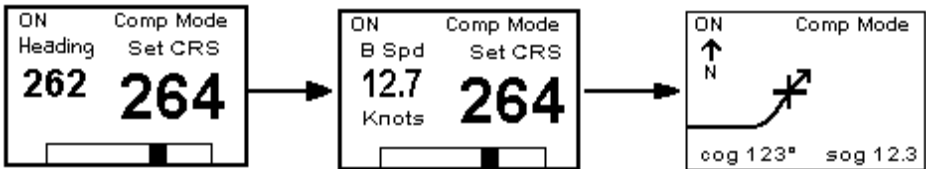

Note: **Compass Mode** shown above. **Wind** and **Navigation** modes are similar (see Pages 7 to 10).



disengaging pilot

Disengages the Pilot.

compass mode

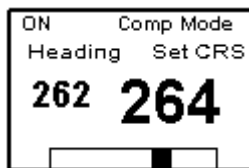

compass mode

With Compass Mode selected and the Pilot switched **OFF**, steer the boat onto the desired heading and allow the boat to settle. Engage the Pilot in **Compass Mode** by pressing the **ON** key once.

The display changes to **Heading** and **Set CRS** (Course). A rudder position indicator bar is also displayed at the bottom of the screen.

Course changes can now be made by turning the **rotary knob**, or by pressing the **-10°** and **+10°** increment keys.

dodging

Press the **-10°**, key or turn the **rotary knob** anti-clockwise to alter course to port in 10° or 1° increments.

Press the **+10°** key or turn the **rotary knob** clockwise to alter course to starboard in 10° or 1° increments.

Multiple presses of the keys are added together to give the required course change; e.g. for 20° to port press **-10°** twice, for 11° to starboard press **+10°** then one "click" of the **rotary knob** clockwise. Alternatively, the rotary knob can be used exclusively to dodge around objects.

The previous autopilot course is automatically stored in memory. Press the **ON** key twice within four seconds to resume the previous course.

memorising the new course

Press and hold the **ON** key for two seconds to update and store the new course in the autopilot course memory. It is suggested that this be carried out after every permanent course change; i.e. not when you have just dodged around an obstacle.

compass mode

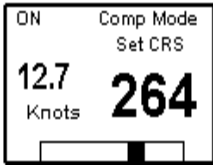
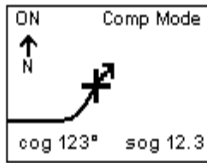
2nd page3rd page**additional compass pages**

With the pilot **ON** pressing the **UP/DOWN** keys will scroll the display to a second and third Compass Mode page.

Page 2 displays boat speed, course and rudder position.

Page 3 displays a track screen of the current data, if position information is available.

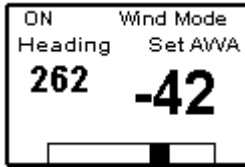

wind mode

In Wind Mode, the Pilot will steer a course that maintains a set target Apparent Wind Angle (**Set AWA**) or True Wind Angle (**Set TWA**). If the wind shifts, the Pilot will alter course so that the actual wind angle to the boat remains the same.

With Wind Mode selected, steer the boat until the desired AWA is displayed and allow the boat to settle. Activate the Pilot in Wind Mode by pressing the **ON** key once. Wind angle changes are made by turning the **rotary knob** the desired number of degrees, or by pressing the **10°** keys to achieve the desired correction.

true wind angle

If a boat speed input from a paddlewheel sensor is available, the Pilot has the added facility to steer to TWA. This gives increased steering stability, particularly downwind. Steer to TWA is selected by setting **TWA Mode** to **ON**, which is found in the **Pilot Memories** menu. Refer to Page 11 of this manual.

automatic tack

The *h1000 Pilot* has the ability to perform an automatic tack, which is particularly useful when sailing short-handed

The auto tack function is selected by pressing the **ENTER** key once, choosing **Tack**, and selecting **now** or **after delay**. Selecting **now** will immediately tack the boat whilst **after delay** will tack the boat after a pre-set countdown period. The Tack Countdown time can be adjusted within the **Pilot Memories** menu.



2nd page

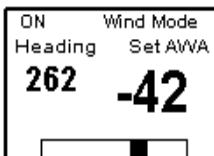

3rd page

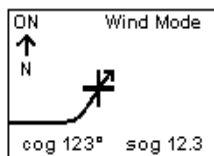

additional wind mode pages

With the pilot **ON** pressing the **UP/DOWN** keys will scroll the display to a second and third Wind Mode page.

Page 2 displays actual wind angle, target wind angle and rudder position.

Page 3 displays a track screen of the current data, provided that position information is available.

navigate mode

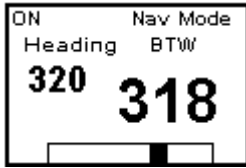

navigate mode

In Nav Mode, the Pilot can be used to steer to a waypoint created by the *h1000 CND (Central Navigation Display)* or from an external source via NMEA.

With **Nav Mode** selected and the Pilot switched **OFF**, steer the boat onto the Bearing to Waypoint (**BTW**), ensure that the cross track error is less than 0.1Nm, and allow the boat to settle. Activate the Pilot in **Nav Mode** by pressing the **ON** key once. When engaged in **Nav Mode**, the Pilot will steer a course that aims to keep the cross track error to a minimum and will allow the boat to safely arrive at the next waypoint.

automatic waypoint advance

Many position fixers will automatically switch to the next waypoint in a sail plan. For reasons of safety however, the *h1000 Pilot* will not automatically steer to the next waypoint until instructed by the user. If the position fixer is transmitting valid waypoint route information, and automatically switches to the next waypoint in a route, the Pilot will prompt the user with the message **Next Waypoint ?**. When it is safe to do so, press the **ENTER** key within four seconds to instruct the Pilot to start navigating to the next waypoint in the route.

2nd page

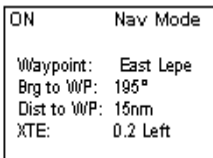

3rd page

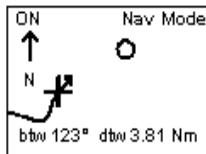



additional navigate mode pages

With the pilot **ON** pressing the **UP/DOWN** keys will scroll the display to a second and third Nav Mode page.

Page 2 displays navigation information relative to the selected Waypoint.

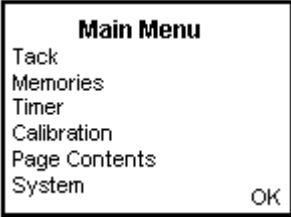
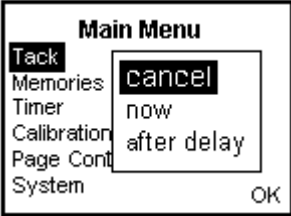
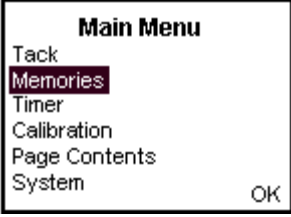
Page 3 displays a track screen of the current data. A circle on the screen indicates the active waypoint.

 <p>Main Menu Tack Memories Timer Calibration Page Contents System OK</p>	<p>main menu</p> <p>The Main menu is accessed by pressing the ENTER key. The items listed in this menu differ slightly dependent upon the boat type and units connected to the system. The 'tack' item will only be listed if the wind interface is connected and the Pilot configured for sail in Dockside Calibration.</p>
 <p>Main Menu Tack Memories Timer Calibration Page Cont System OK</p> <p>cancel now after delay</p>	<p>Tack (see also Page 9 of this manual)</p> <p>cancel aborts the tack function</p> <p>now will immediately start the automatic tack function</p> <p>after delay starts the automatic tack function after an adjustable time period.</p>
 <p>Main Menu Tack Memories Timer Calibration Page Contents System OK</p>	<p>memories</p> <p>The Memories menu contains functions which are accessed more frequently and can be changed with the Pilot OFF or ON.</p>
 <p>Memories Pilot Compass Reset trip log Alarms Lighting OK</p>	<p>The memories menu may be accessed to configure the settings for the Pilot, Compass, Alarms and Lighting, and to reset the trip log.</p>

pilot memories

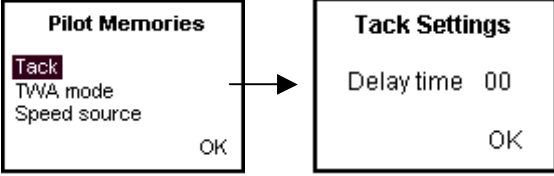
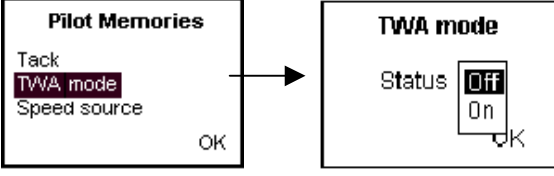
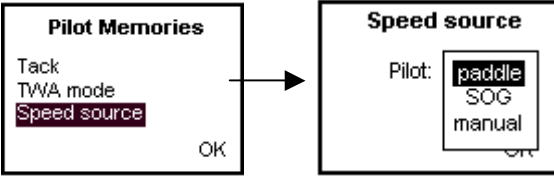
 <p>Memories Pilot Compass Reset trip log Alarms Lighting OK</p>	<p>Pilot Memories</p> <p>Pressing the ENTER key with Pilot highlighted takes the user into the Pilot Memories pages.</p>
 <p>Pilot Memories Tack TWA mode Speed source OK</p> <p>Tack Settings Delay time 00 OK</p>	<p>Tack (see also Page 9 of this manual)</p> <p>Pressing the ENTER key with this option highlighted displays the auto tack function delay time setting, adjustable between 0 and 99 seconds. The default setting is 10 seconds.</p>
 <p>Pilot Memories Tack TWA mode Speed source OK</p> <p>TWA mode Status Off On OK</p>	<p>TWA mode (see also Page 9 of this manual)</p> <p>Pressing the ENTER key displays the status for TWA mode. Selecting ON configures the Pilot to use TWA information when steering in Wind Mode. This function is particularly useful for optimising downwind steering performance</p>
 <p>Pilot Memories Tack TWA mode Speed source OK</p> <p>Speed source Pilot: paddle SOG manual OK</p>	<p>Speed source</p> <p>The speed source option allows the source for speed data to be selected. Pressing the ENTER key displays the three options available, paddle, SOG (from a GPS) and manual. Pressing the UP/DOWN key toggles between the options.</p> <p>Selecting the manual option activates a further screen, which allows adjustment of the three manual speed settings, slow, medium and fast. Alter these settings to the most appropriate values for the particular boat.</p>

Compass

The compass memory allows a pre-set heading to be defined and any deviation from that course will be shown as an error on the Tactical Compass page. This course can be updated by one of three methods. The first method, is simply by pressing the **ENTER** key whilst the display is showing the Tactical Compass page. The second is by using the drop down box in the **Memories** → **Compass** → **Course**, drop down menu. The drop down box offers **Use heading** which sets the course to the heading the boat is presently steering to and **User defined** which allows a pre-set value to be entered.

PORT and STBD courses (sailboats only) are retained and updated at each press of the **ENTER** key whilst in the Tactical Compass page. When **OK** is selected, control returns to the **Memories Menu**.

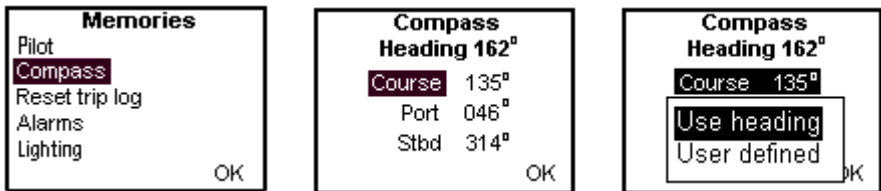

reset trip log (this function is only available if a speed input is present)

Reset trip log clears the trip log value back to zero. The stored log however is unaffected by this operation. Pressing the **UP/DOWN** key toggles between **OK** and **Cancel**.

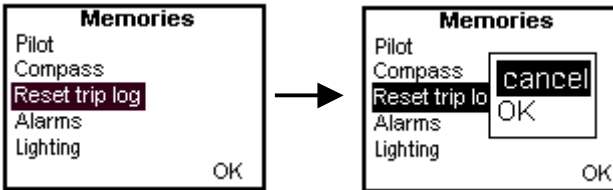

alarms

Alarm levels for various measured functions can be set, or inhibited. All the alarms default to **OFF** on a factory reset.

If available on the system, the **Wind speed**, **Shallow depth**, and **Off course** alarms can be set from the **Alarms** menu. Selecting **Pilot** activates the Pilot Alarms screen where the **Watch timer** and **Pilot off course** alarms can be set.

It should be noted that two **Off course** alarms are available with the *h1000 Pilot* system. The first, which is located directly on the **Alarms** menu, is triggered from the **Tactical Compass** page. The second **Off course** alarm, located within the **Pilot Alarms** menu triggers only when the Pilot deviates from the Pilot Set Course.

alarms

The setting procedure for the wind speed alarm is shown. The other alarms are set in a similar manner.

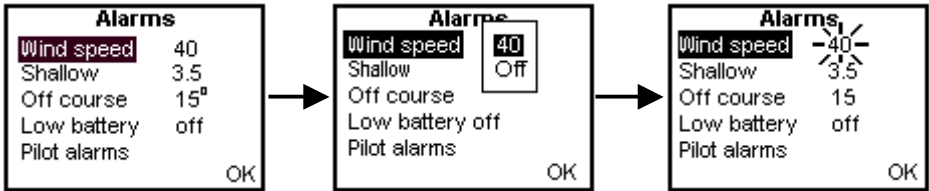

Note: The low battery alarm is pre-set at 10.5 volts, and can only be turned **ON** or **OFF**.

lighting

lighting

Display lighting levels are controlled by the **lights** key in normal operation, but the exact level of illumination can be adjusted for each of the three settings from this menu.

The levels are numbered in the order they appear when the **lights** key is pressed, and each level can be set as a percentage from 00% (off) to 99% (maximum).

This menu page also allows the lighting control to be applied either as **local** (this display unit only), or **system** (the entire system) and is useful when zoning particular displays on the boat. For example, cockpit display lighting can be isolated from a display located down below.

The **OK** command returns to the **Main Menu**.

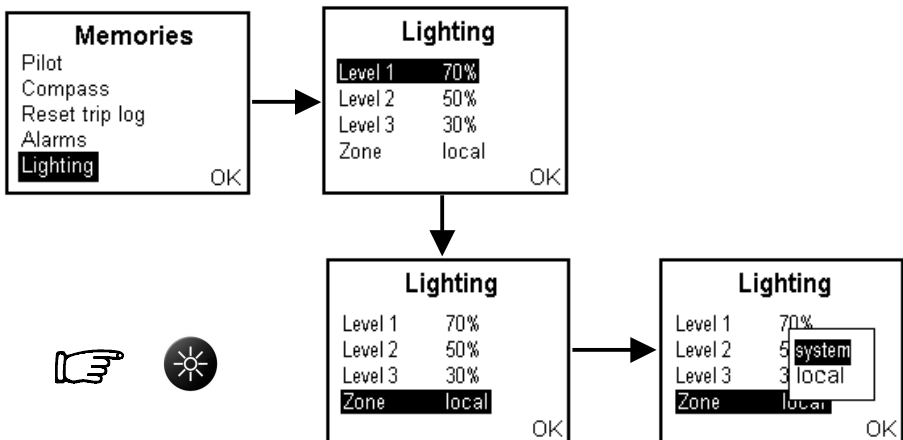

timer

The timer can be used for counting down to the start of a race and to record elapsed time. The timer can be set to countdown anywhere from 1 minute to a maximum of 59 minutes in 1-minute increments. Once started, the timer will continue to run in the background, even if the timer configuration page is exited. The Timer function can be displayed in any of the User Pages.



calibration

Note: For full details of calibrations for your h1000 pilot refer to the Installation Manual supplied with your unit.

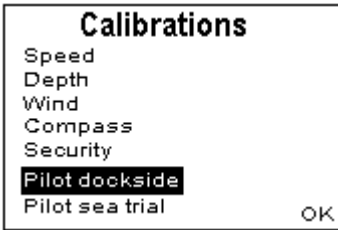

Calibration

Calibration values take time and effort to set up and it is often necessary to perform various manoeuvres with the boat. For this reason, an optional security check is provided before entry into the calibration menus to save accidental resets. Refer to the **h1000 Pilot Installation Manual** for full details covering **Compass, Dockside and Sea trial** calibrations.

entering secure mode

This feature is optional and can be disabled.

The security check uses a four digit Personal Identification Number or PIN. If security has been activated, this PIN must be entered every time to access the **Calibrations** menu.

After a factory reset the PIN is set to 0000 and in this condition security checking is disabled.

Security is an option on the **Calibrations** menu, which allows a new PIN to be set. Once a non-zero PIN has been set the security checking is enabled, and all subsequent access to the **Calibration** menu is restricted.

Note: Once the PIN has been entered for any given session the PIN entry screen is automatically by-passed when re-entering the calibration menu. Upon cycling the power, the PIN is once again required to enter the calibration menu.

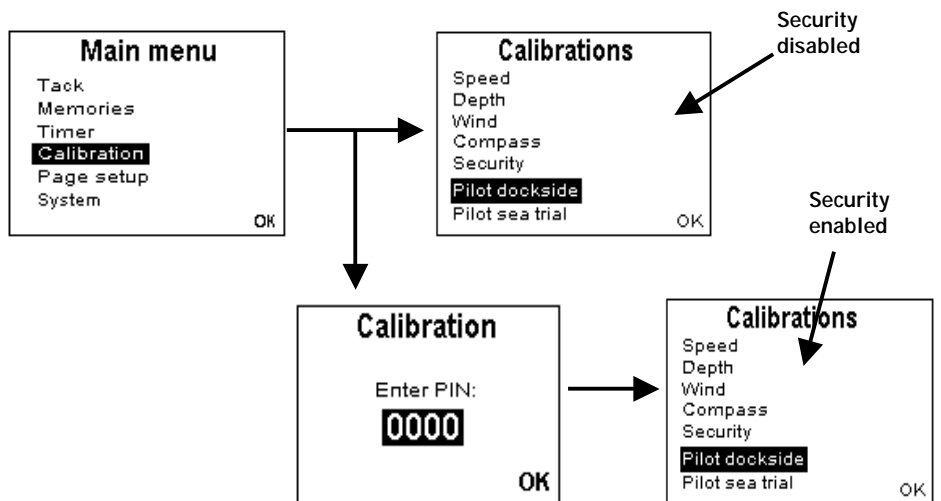

precautions

To avoid electromagnetic interference, it is recommended that the Pilot display be installed no less than 0.3 metres from a compass and 1 metre from a GPS.

The Pilot is water resistant, but not waterproof. Use the cover when not in use. The rear connectors that are not connected to cables must remain protected by their appropriate caps.

panel mounting

Ensure there is sufficient room behind the panel to accommodate the fixings and connections, and using the template supplied, cut a hole in the panel in the desired position.

Fix the mounting bracket into the hole using the screws supplied.

Note: The sealing ring is fitted to the unit during manufacture. Its purpose is to prevent moisture penetration and reduce the effects of any vibration transmitted through the instrument panel.

Press the **Pilot Display** firmly into the mounting bracket; an audible 'click' will indicate that the case is correctly located.

Secure the unit to the instrument panel by fitting the studs and thumbnuts supplied.

Caution: To avoid damaging the casing, fixing studs must only be tightened 'finger-tight'.

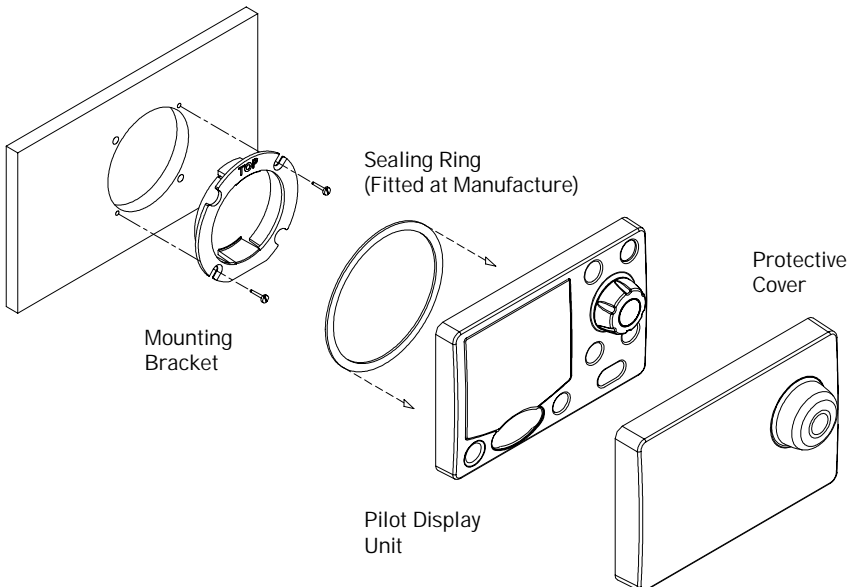

electrical connections

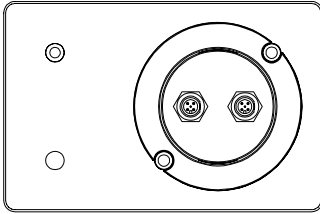

external connections

Two Fastnet² connectors are provided at the rear of the unit.

The table below shows pin functions.

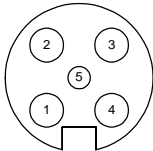

Front view of male connector pins

Pin Number	Signal
1	12 volts
2	Busy
3	Fastnet ² -
4	Fastnet ² +
5	0 volts

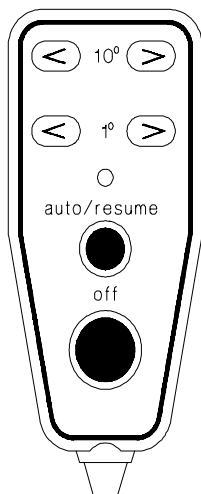

Hand-held controller

The Hand-Held Controller provides remote control over the *h1000 Pilot*. The functions of the six dedicated keys are as follows:

- (a) **10° >** Ten degree turn to Starboard
- (b) **<10°** Ten degree turn to Port
- (c) **1° >** One degree turn to Starboard
- (d) **<1°** One degree turn to Port
- (e) **auto/resume** Switch the Pilot ON/
Resume the previous course
- (f) **off** Switch OFF the Pilot

The Hand-Held Controller has an LED indicator that flashes to indicate the *h1000 Pilot* is operating correctly.

accessories

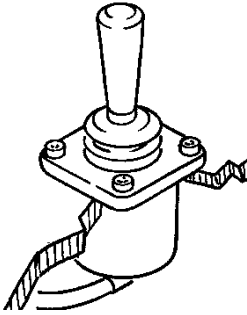

Joystick Control

joystick control

The Joystick allows direct control of the rudder via the autopilot computer for quick and responsive steering. The Joystick has two modes of operation available to the helmsman, giving different steering control as follows:

normal

In this mode the rudder moves in the direction of the joystick movement, when the joystick is returned to the central position, the rudder movement stops. The greater the movement of the joystick, the faster the response of the rudder.

proportional

In this mode the position of the rudder imitates the position of the joystick. When the joystick is returned to the central position the rudder returns to its initial position.

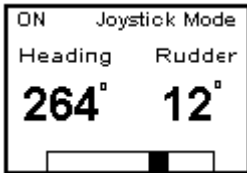
**engaging the pilot in joystick mode**

To engage the Pilot:

- Turn rudder to amidships position
- Press the **joystick** key to engage the Pilot
- Move the joystick to Port or Starboard to move the rudder

Note that when the Pilot is engaged using the joystick key, the rudder position at the moment of engaging will be the central position of the joystick.

disengaging the pilot from joystick mode

The joystick can be de-activated by either:

- Pressing the **Joystick** key
- Pressing the Red **OFF** key on the Pilot display
- Pressing the Red **OFF** key on the Hand-Held Controller

When the Pilot is disengaged from the Joystick mode, the *h1000 Pilot* will return the mode selected prior to the joystick being engaged.

Note: The **Joystick Mode** can only be accessed when the Pilot is in the **OFF** state in **Compass**, **Wind** or **NAV** modes and cannot be selected if the Pilot is already engaged.

man overboard (mob) mode

man overboard key

The **Man Overboard** key is an optional extra which activates the *h1000 Pilot's* man overboard procedure.

For the **MOB** function to operate, the Pilot system must have a boat speed input from a paddlewheel sensor. The procedure will not operate when the Pilot is set to manual pre-set speed bands or from speed over ground (SOG).

There are two distinct differences in the **MOB** procedure dependent on the configuration of the Pilot, which is either **Power Boat** or **Sail Boat**.



power boats

When the *h1000 Pilot* is installed on powerboats, the Pilot can be used for automatic recovery. The Pilot controls the steering of the boat and executes a "Williamson Turn" to steer the boat on a reciprocal heading (course) back to the point at which the **MOB** key was initially pressed.

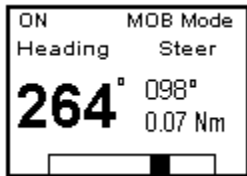

sail boats

When the *h1000 Pilot* is installed on a sail boat, for safety reasons and the need for the boat to tack and gybe back onto the reciprocal course, **automatic recovery** is disabled. The user must follow the dead-reckoned distance and course displayed on the Pilot screen to manually return the boat to the point at which the **MOB** key was initially pressed.

mob manual recovery: for all boats, pilot off

1. Press the **MOB** key as soon as the person is lost overboard.
2. All digital displays will flash the **MOB Alarm Message** and the alarm will sound (if connected).
3. Pressing any key on the *h1000 Pilot* display silences the **MOB** alarm. This action clears the alarm screen and the display now shows the bearing and distance to where the incident occurred. The bearing and distance to the casualty are shown under the title "**Steer**" on the right hand side of the LCD.
4. The boat should now be manually steered back to where the incident occurred by following the bearing and distance shown on the Pilot display.
5. Recover the person(s).
6. The MOB feature can be disabled, by pressing and holding down the **MOB** key for five seconds until the display clears. The Pilot will now default to **OFF Compass Mode**.

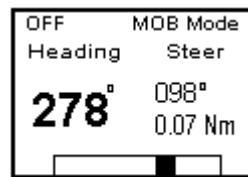

mob manual recovery: for all boats, pilot on

1. Press the **MOB** key as soon as the person is lost overboard.
2. All digital displays will flash the **MOB Alarm Message** and the alarm will sound (if connected).
3. Pressing any key on the *h1000 Pilot* display silences the **MOB** alarm. This action clears the alarm screen and the display now shows the bearing and distance to where the incident occurred. The bearing and distance to the casualty are shown under the title "**Steer**" on the right hand side of the LCD.
4. The boat should now be manually steered under autopilot control back to where the incident occurred. This is done with the use of the **-10°**, **+10°** keys (display or hand-held) and the **rotary knob** and following the on-screen bearing and distance to where the incident occurred.
5. Recover the person(s).
6. The MOB feature can be disabled, by pressing and holding down the **MOB** key for five seconds until the display clears. The Pilot will now default to **OFF Compass Mode**.

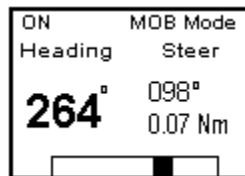

mob procedure

mob automatic recovery: power only, pilot on

1. Press the **MOB** key as soon as the person is lost overboard.
2. All digital displays will flash the **MOB Alarm Message** and the alarm will sound (if connected).
3. Pressing any key on the *h1000 Pilot* display silences the **MOB** alarm. This action clears the alarm screen and the display now shows the bearing and distance to where the incident occurred. The bearing and distance to the casualty are shown under the title "Steer" on the right hand side of the LCD.
4. If necessary, reduce the boat speed to less than 8 knots.
5. Press the **MOB** key three times in quick succession to initiate the **MOB automatic recovery**.
6. The autopilot will now control the steering and perform the Williamson Turn back onto the reciprocal heading.
7. Press the **OFF** key to disengage the Pilot as you approach the incident and recover the person(s).
8. Press and hold the **MOB** key for five seconds to cancel the MOB function and clear the display of MOB data.
9. The Pilot will now default to **OFF Compass Mode**.

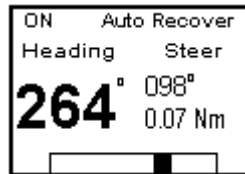
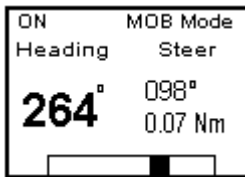

Notes:

1. Activating the **MOB Alarm** via the Pilot **MOB** key will also activate the MOB feature on the CND if connected via the Fastnet².
 2. Activating the **MOB Alarm** via the CND MOB key will also activate the MOB feature on the Pilot if connected via the Fastnet².
 3. The **Automatic Recovery procedure** cannot be initiated from the CND.
-

technical specifications

Dimensions:	110mm x 170mm
Power Supply	10-16 volts dc
Power consumption (Display):	50mA (Lights OFF) 200mA (Lights ON)
Power Consumption(Processor):	50mA (Excludes Ram & Accessories)
Autopilot Interface: Interface)	NMEA 0183 ver 2.3 (via Universal
Display:	LCD Panel FSTN
Display Resolution:	120 x 80 pixels
Temperature range:	-10/+60 degrees Celsius
Memory:	EEPROM
Keyboard:	Silicon rubber, backlight
Accessories:	Joystick Hand-held Remote Control MOB Button Paddlewheel External Alarm

warranty

1. warranty

Brookes & Gatehouse Limited (“B&G”) guarantees this product against defects in materials or workmanship on the terms and conditions set out below (the “Warranty”).

2. warranty period

The Warranty continues for 24 months from the date of purchase by the user’s (excluding mechanical items, including but not limited to, autopilot drive units which are subject to 12 months warranty). It is the user’s responsibility to demonstrate the date of purchase by showing a valid warranty card or proof of purchase. If the user cannot do this the date of purchase shall be deemed to be the date of manufacture as evidenced by the serial number of the product.

3. repair and replacement

During the Warranty period and subject to the terms and conditions set out below B&G will repair or, if it so chooses, replace the product. It is the user’s responsibility to arrange and pay for transport of the product to the nearest authorized B&G representative and any re-installation required following repair. B&G shall not be responsible for any such costs, including (but not limited to):

- 3.1. Boat slipping or lifting;
- 3.2. Freight shipping charge;
- 3.3. Engineer’s travelling time and expenses;
- 3.4. Installation labour costs associated with the Warranty claims; and
- 3.5. Loss or damage of products or boats in transit.

4. conditions

The Warranty will not apply in the following circumstances:

- 4.1. Where the product has been installed in a manner or location other than that specified in the installation instructions;
- 4.2. Where the product has been serviced or repaired by anyone other than an authorized representative;
- 4.3. Where the product has been used for purposes for which it is not intended;
- 4.4. Where the product has been used in a manner other than that described in the manual supplied; or
- 4.5. Where the damage is caused by exceptional events such as (but not limited to):
 - Abnormal levels of magnetic, electrical or acoustic interference;
 - Lightning strikes;
 - Accidents;
 - Intentional damage; or
 - Negligent use.

5. wear and tear

The Warranty is limited to defects in materials or workmanship and does not cover normal wear and tear such as (but not limited to) corrosion and damage caused through the day to day running of the boat.

6. software

B&G shall not be liable under this Warranty or otherwise for any defect in software incorporated within the product.

7. further warranties

The Warranty set out in this document is the only Warranty offered by B&G. B&G makes no further promises in relation to this product such as (but not limited to):

- 7.1. That it is suitable for any particular use; or
- 7.2. That it conforms to any particular quality standards.

8. transfer

This Warranty is not transferable.

9. consequential loss

B&G shall not be liable for any damage to persons, yachts, equipment or any other property or for any other kind of consequential loss.

10. governing law

This document is governed by and shall be construed in accordance with English law.

11. statutory rights

This Warranty is offered as an extra benefit and does not affect your statutory rights against the party who sold you the product.
